



An Interdisciplinary Laboratory Cluster of Excellence at the Humboldt-Universität zu Berlin

Image

Knowledge

Gestaltung

Newsletter

December 2014

#5

Editorial	p. 2
The LunchTalk in the Interdisciplinary Laboratory – Reports from November & December 2014	p. 3
Representing the Complexity of Life. From the Molecule to the Virtual Liver	p. 4
The Kitchen of the Future	p. 8
gamelab.berlin	p. 13
In Conversation with ...	p. 17
Rasa Weber, Sophia Kunze, Julia Meer: Individual Grants	p. 17
Review	p. 21
Workshop for the Master's in »Open Design«	p. 21
Annual Conference of the Interdisciplinary Laboratory	p. 24
Report from the Anthropocene Campus at the Haus der Kulturen der Welt	p. 30
Imprint	S. 35

Editorial



With the planning game *Decide & Survive*, Steven Kawalle put a political science theory to the test. Cluster members played for the survival of their states. (Photos: Thomas Lilge | BWG 2014)

Dear Readers,

With 43 *LunchTalks*, 42 issues of the Cluster newspaper, *CZ#*, eight conferences, three *Interdisciplinary Controversies*, four workshops for research associates and countless working meetings for the base projects, a very eventful 2014 is drawing to an end for the Interdisciplinary Laboratory *Image Knowledge Gestaltung*. The topics discussed ranged from repro photography and echolocation via data visualisations and design as research, right the way through to knowledge architectures and interdisciplinary access to information technology, the use of diagrams in research and science, and cooking insects.

In *Newsletter#5*, we present the highlights of the past two months. You can read a *LunchTalk* report by Bettina Bock von Wülfingen on the complexity of modelling against a backdrop of a greater demand for more complex information on the function and interaction between the modelled biological elements. In our other *LunchTalk* reports, you can hear about designing the kitchen of the future from the base project »The Anthropocene Kitchen«, and members of gamelab.berlin tell us about their projects, visions and themes of their work.

Since March 2014, the Cluster's individual grants have responded to the very different needs of the staff of the *Interdisciplinary Laboratory*. Within the framework of promoting diversity in the Cluster, individual grants support up to 25 applications per year from employees of all status groups.

After the first application rounds, *CZ#* met up with employees who have successfully applied for funding for different activities to support their careers. Read about using algae to produce sustainable design and a book and exhibition project on the designer Jacqueline Casey, which is being developed in co-operation with the MIT Museum in Boston (p. 17).

»Plenty of space for questions and discussion by those involved in research. That is living interdisciplinarity.« That was the verdict of a visitor at the annual conference of the *Interdisciplinary Laboratory* in November. With more than 280 guests, the conference generated a great deal of interest. The proceedings of the conference will be published at the beginning of 2015. You can see the best pictures of the conference from page 24.

There are also reports about the Anthropocene Campus at the Haus der Kulturen der Welt and about the workshop for future lecturers for the master's programme »Open Design« in Buenos Aires, Argentina, on page 21.

I wish you all the best for the coming year and would like to thank you for your interest in the *Interdisciplinary Laboratory*.

Enjoy reading *Newsletter#5*.

Best regards,



Claudia Lamas Cornejo
Head of Public Relations & Fundraising

The *LunchTalk* in the *Interdisciplinary Laboratory*



The *LunchTalk* in the *Interdisciplinary Laboratory* is held weekly from 12.30 to 2 pm on Tuesdays. External persons may attend on request. (Photo: Claudia Lamas Cornejo | BWG 2014)

The *LunchTalk* is a permanent fixture in the Cluster week at the *Interdisciplinary Laboratory*. On Tuesdays from 12.30 to 2 pm, members of the Cluster or invited speakers give a talk on relevant topics. Cluster members then discuss the talk in order to identify points of reference, interfaces with or differences to their own work in the Cluster. The *LunchTalk* provides members with an opportunity to exchange ideas informally and discuss issues in their research in a protected internal space. Here they can air theses and findings that are not yet 100% ready for publication and discuss them with researchers in different disciplines. This is why the *LunchTalk* is, as a general rule, not open to non-members of the Cluster. If you are interested, please send an enquiry to bwg.publicrelations@hu-berlin.de. Suggestions for contributions by external speakers can also be sent to this address.



Claudia Lamas Cornejo
Head of Public Relations & Fundraising

LunchTalk Reports



LunchTalk Report Representing the Complexity of Life. From the Molecule to the Virtual Liver

The *LunchTalk* on 11 November 2014 was on a part of my study in the base project »Gender and Gestaltung« that links back to my collaboration with a colleague, Niki Vermeulen at the University of Edinburgh. We gave a presentation on it at the conference of the Society for the Social Studies of Science (4S) in Buenos Aires with the Cluster's kind support. We linked the results of Niki Vermeulen's work on the German research project *The Virtual Liver* and my study in the Cluster on imaging in reproduction and genetics research around 1900 and 2000. Its part in recent research explores the field of reproductive genetics. This links an approach grounded in the history of science with science and technology studies, which follows a Rheinbergerian historical epistemology in my research.

In our joint project, the central thesis that has been generated from the results of both studies is that, in order to model complexity, a shift in perspective towards the kind of connections between the modelled elements is required. The point of departure for this approach is that, on the one hand, a greater demand for more complex

information on the functions and interactions between biological elements has prevailed since around the turn of the millennium, when the Human Genome Project was able to supply the genetic code but could say little about the significance of the data it generated.

On the other hand, the perception is widespread that by integrating yet more data, more complexity would inevitably be achieved, life could be understood, and health and environmental problems solved. Instead, Niki Vermeulen's and Bettina Bock von Wülfingen's results indicate a shift in the kind of relationships in complex networks: instead of being modelled unidirectionally, such as the genetic cause of phenotypic effects on organs or the body, »equal relations« between different elements and levels are modelled. These are based on special system approaches and, as a result, the directions of effect are now also conceptualised in reverse.

Explanatory models, for example, in the field of reproductive genetics, which investigates issues of fertility or possible physical abnormalities in offspring using genetic methods, overwhelmingly followed the direction of genetic

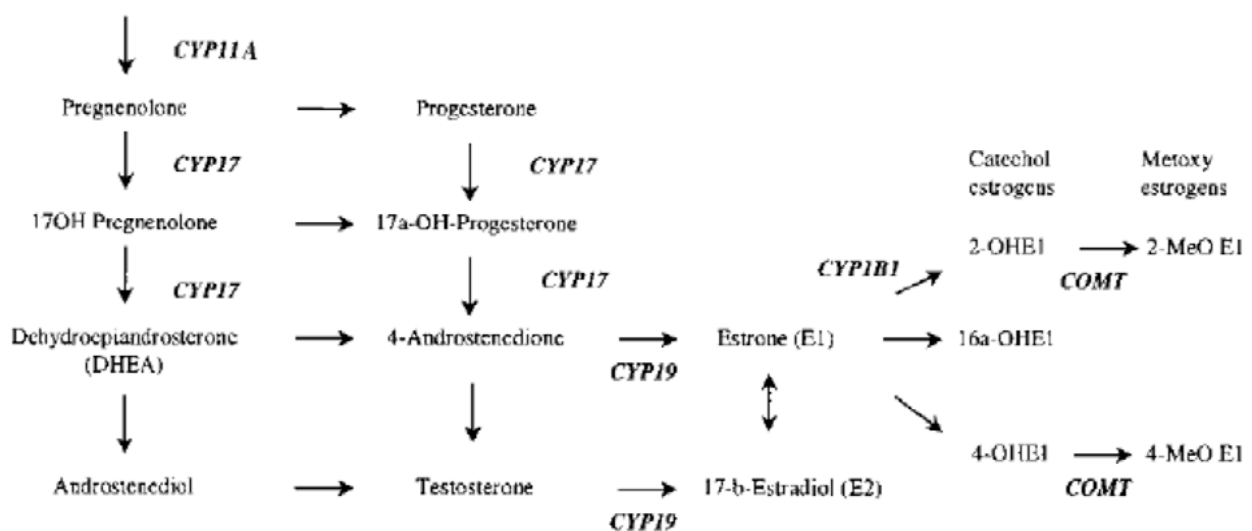

Fig. 1: A hormonal »biochemical pathway« (synthesis pathway) that describes the synthesis of steroid hormones, such as oestrogen and testosterone. The genes involved are noted on the arrows. (García-Closas et al. 2002)

cause to the phenotypic effect on the organ or body until around 2005. This can often be seen in tables in which the gene in question and the affected proteins are listed opposite each other. The symbol of the clear directional arrow in more complex studies indicates that questions were asked and answers proposed in this way of thinking, simultaneously perpetuating it.

The complexity of such representations of *biochemical*

pathways has increased enormously since the 2000s, as can be seen by comparing the world standard, Michal's static atlas (Michal 1993; the latest version has been available online since 2014), with the online tools that have emerged since then. These tools are supported by databases of the relevant organisms and molecules, which can be selected and modified from the atlas (such as the atlas by Kanehisa Laboratories, Fig. 3).

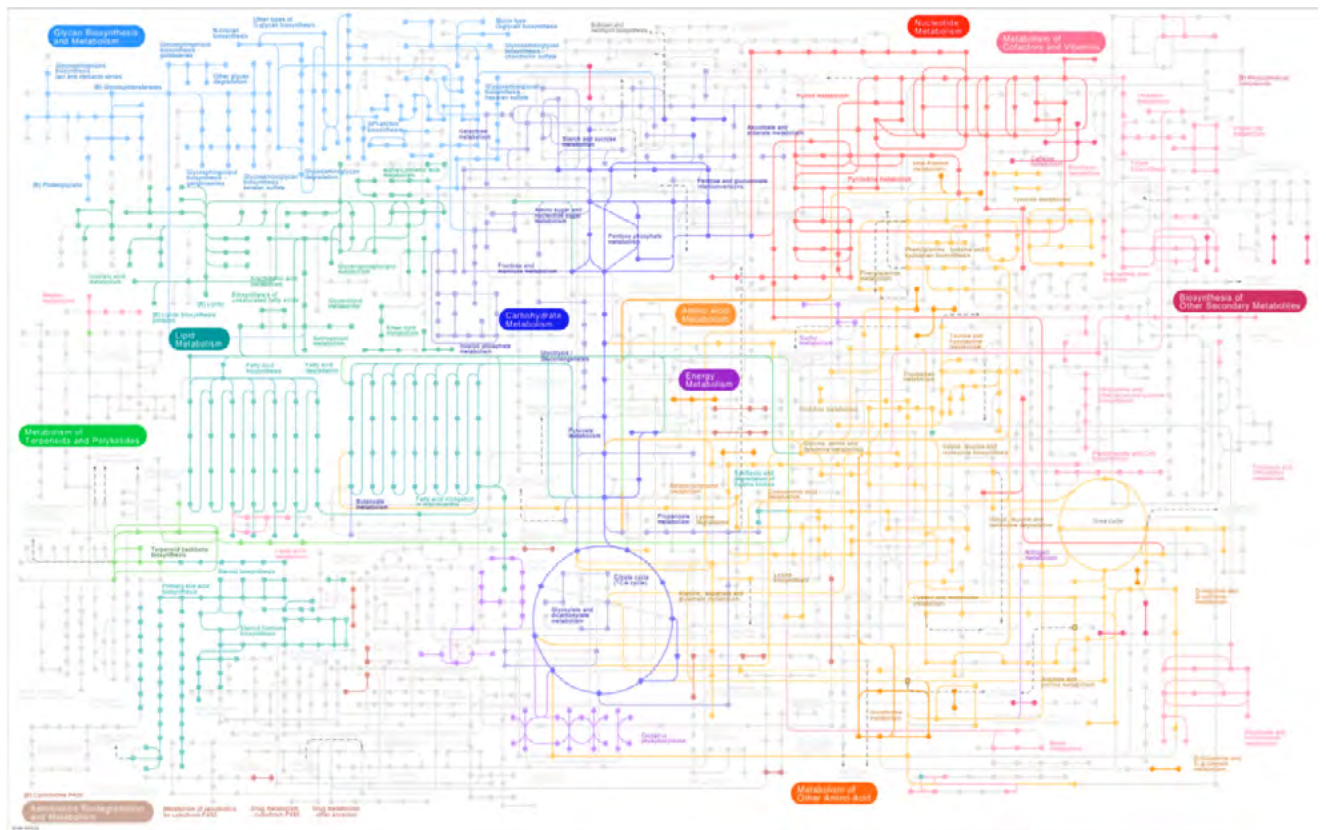

Fig. 3: The »metabolic pathway« by Kanehisa Laboratories. This example shows the metabolism of a Chinese hamster. The working group calls its work the »Kyoto Encyclopedia of Genes and Genomes«, which clearly distinguishes it from an atlas (Kanehisa and Goto 2000, <http://www.genome.jp/>). Without using arrows, it crosses the border into the outside world by including extra-organism materials, such as xenobiotics (in brown). DNA is shown in light red, the colour of the gods in the Shinto faith.

But within reproductive genetics too, improvements in the possibilities for handling large quantities of data are noticeable (Bock von Wülfingen 2009). It was claimed when the microarray was introduced that it would enable the entire genome to be »printed« very quickly. Since the introduction of this technology, feedback and mutual influences between genes, between proteins but also by proteins on genes have been discussed in reproductive genetics and integrated into epigenetic approaches (e.g. Sermon 2011).

Genome analyses or transcriptome analyses, which provide information on gene activities, are conducted not only on individual cells but also on complete tissues. As a result, interactions are examined not just on one level (inside the molecules of the cell or between cells, for instance) but between two levels, such as the cell and tissue. On the one hand, a »bottom up« approach (from the molecule upwards) supplements a »top down« approach. On the other hand, steps are being made towards three-dimensional models with real data.

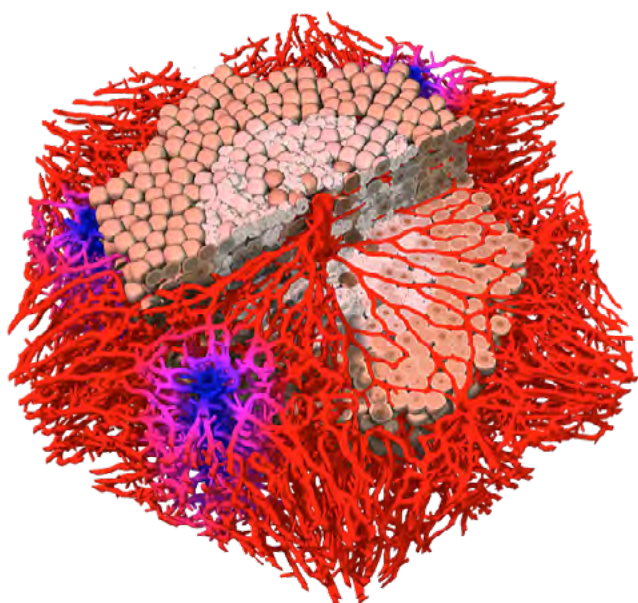

Fig. 4: Animation of a liver lobule under intoxication, Hoehme et al. 2010; an animated version can be found at <http://www.hoehme.com/>.

The German *Virtual Liver Network* (which runs until 2016) is currently attempting to model yet more levels and even interactions with the environment. Its starting point is the credo of the physiologist Denis Noble: »There is no privileged level of causality in biological systems« (Noble, 2011: p. xxi; see an example of its work on the virtual liver in Fig. 4).

In each case, upward and downward causation are linked with each other. At the same time, the researchers in the network are conscious that they themselves are a complex network and that they are only able to model with the complexity they strive for with such co-operative interdisciplinarity and together with hospitals and businesses. Despite this, Vermeulen's observations of meetings showed that the Virtual Liver Network has only included data from the livers of male subjects until now. This is relevant as these representations are regarded simultaneously as a database and Petri dish, as a simulation and experiment (Merz 2006, Morgan 2005). They consequently go from being a tool to being the actual biological subject and increasingly assume an ontological status for biology (Saks et al. 2009).

A further example shows the wider relevance outside historical epistemology of questions about the kind of relationships in models and about the complexity they achieve. I am currently co-operating on an application to the EU with different research groups that are working on a virtual brain. The reason for this application is that the European flagship project the *Human Brain Project* has already received 50 million euros from the EU to date this year. In an open letter that was published internationally this summer with a list of signatories, international neuroscientists called upon the EU to hold back the next tranche of 50 million euros as this project does not promise to yield any meaningful results (Regalado 2014). They claim that it follows a top-down approach, both in its human resource management and in its modelling, which does not promise to produce intelligent results. In essence, the issue at stake is the values in research that are used to assess scientific quality and feasibility.

References:

Bock von Wülfingen, Bettina: *Is there a turn to systems approaches in life sciences? The example of reproductive genetics*. In: EMBO reports and Molecular Systems Biology Journal (2009): p. 37-42.



Bettina Bock von Wülfingen
Base project »Gender & Gestaltung« & Diversity

García-Closas, Montserrat, et al.: *Relationship between serum hormone concentrations, reproductive history, alcohol consumption and genetic polymorphisms in pre-menopausal women*. In: International Journal of Cancer 102.2 (2002): p. 172-178.

Hoehme, Stefan & Drasdo, Dirk: *A cell-based simulation software for multi-cellular systems*. In: Bioinformatics 26.20 (2010): p. 2641-2642.

Kanehisa, Minoru & Susumu Goto: *KEGG: Kyoto Encyclopedia of Genes and Genomes*. In: Nucleic Acids Research 28.1 (2000): p. 27-30.

Merz, Martina: *Locating the dry lab on the lab map*. In: Lenhard, Johannes; Küppers, Günter; Shinn, Terry (ed.): *Simulation: Pragmatic Constructions of Reality*. Sociology of the Sciences Yearbook 25. Dordrecht: Springer (2006): p. 155-172.

Michal, Gerhard (ed.): *Biochemical Pathways*. Boehringer Mannheim GmbH (1993).

Morgan, Mary S.: *Experiments versus models: new phenomena, inference and surprise*. Journal of Economic Methodology 12, 2 (2005): p. 317-329.

Noble, Denis: *A theory of biological relativity: no privileged level of causation*. In: Interface Focus (2011): rfs20110067.

Saks, Valdur; Monge, Claire; Guzun, Rita: *Philosophical basis and some historical aspects of systems biology: from Hegel to Noble – applications for bioenergetics research*. International Journal of Molecular Sciences 10 (2009): p. 1161-1192.

Sermon, Karen: *Interview*, 26.5.2011.

Regalado A.: *Neuroscientists object to Europe's Human Brain Project*. In: MIT Technology Review, July 7 (2014); <http://www.technologyreview.com/news/528796/neuroscientists-object-to-europes-human-brain-project/>

LunchTalk Report *The Kitchen of the Future*



The project serves to take stock of the different ideas and key themes in the »kitchen of the future« in the past and the present day.

The kitchen's structure, its physical organisation, technical equipment and furniture changed when the home was connected to new networks: water, gas, electricity, etc. New achievements in engineering entered the kitchen. Interaction between man and machine/device changed and triggered (re)design processes in kitchens. In the Frankfurt Kitchen, for example, kitchen workflows were intentionally designed for the first time. Yet until today, the kitchen has been viewed from an internal standpoint and seen as a closed system. The kitchen has not yet been examined as a part of a larger system from an integrative perspective that includes upstream and downstream metabolic processes.

There is also the issue of the composition of the kitchen's nucleus and the relationship between different functional or space modules.

Our research examines the following questions: what tasks do the interfaces with the kitchen's external supply networks/metabolic systems perform and where are they located? How do they send and receive information? What information is important at which point in time? What opportunities are there to exchange information with and against the material flow? What fundamental metabolic knowledge does the user need?

With the laboratory kitchen, we plan to create a tool that is able to better capture or measure the operational sequences and the energy and material flows in the kitchen, and make them intelligible. Our investigations focus on the changes in size of individual function modules and how their configuration varies depending on the user group, usage techniques and resource flows.

We also plan to use the laboratory kitchen to test and modify »Merkmale« – perception tools that are interfaces encouraging more conscious consumption – in terms of their location, function and actions. In addition, we aim to examine the possibility of changing the material flow by visualising individual consumption compared to other users.

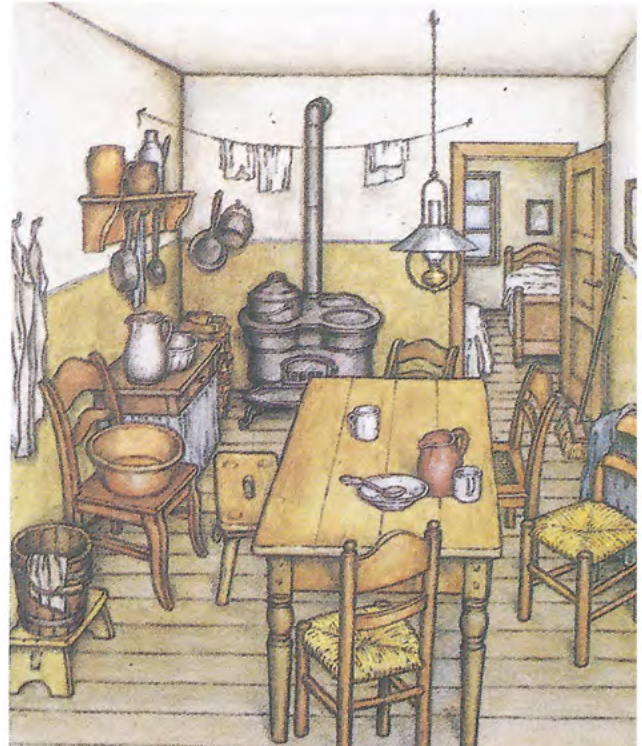

Figure 1: The kitchen around 1800. J. Geist, J. Krausse: Küche, Stube usw. WDR 1978.

Entwurfsplanung

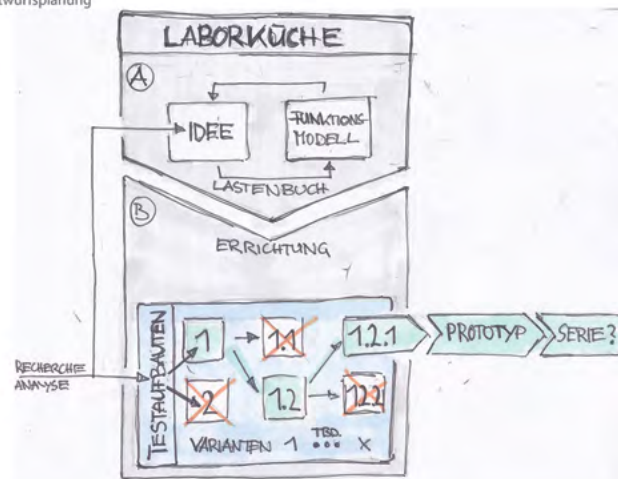

Figure 2: Draft plan for the laboratory kitchen, K.W. Grosse 2013.

globaler zyklischer Materiallauf

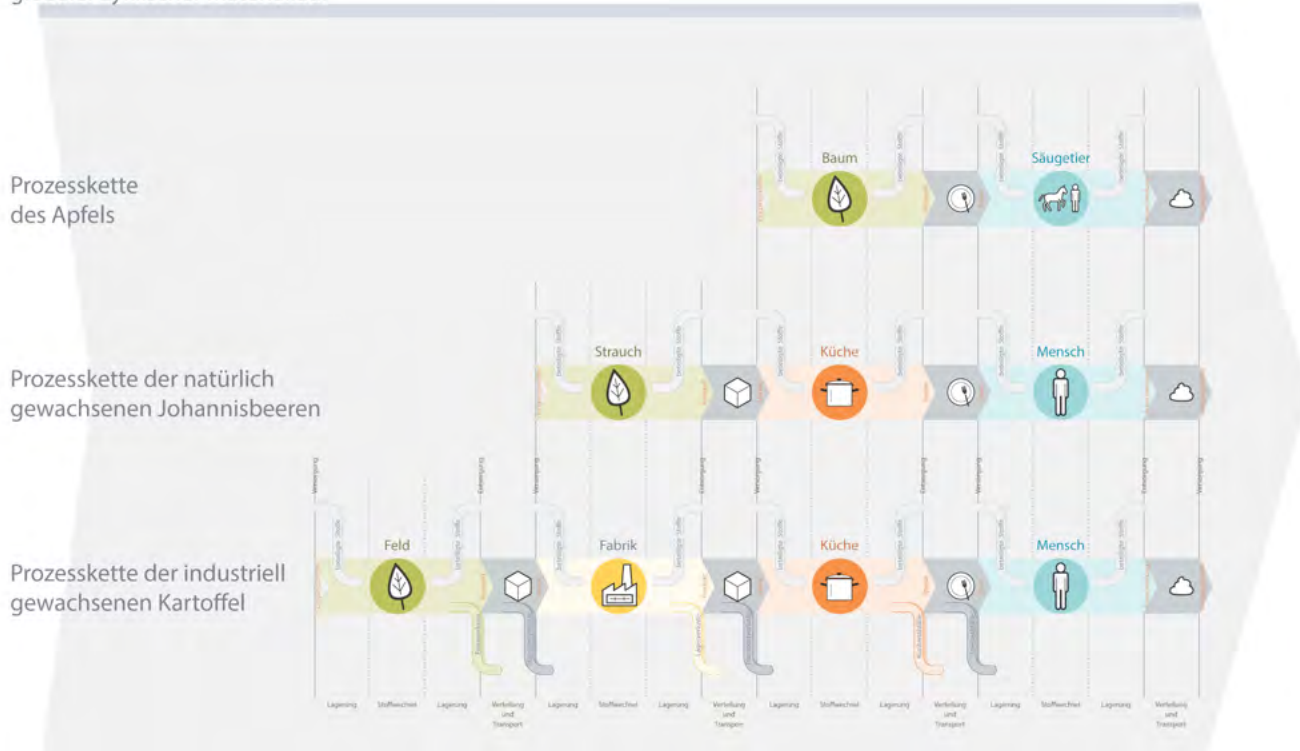

Figure 3: Planetary material flow; K.W. Grosse, J. Krausse, N. Nilaman 2014

Experiments in the laboratory kitchen are filmed in order to analyse internal sequences of movements. The space for the activities is continuously adjusted and optimised based on analyses of movement patterns.

Working with the laboratory kitchen is the foundation for the design that we have announced. All experiments and experiment set-ups are documented in a laboratory log-book. The modular construction of the laboratory means it will be able to react flexibly to space, users, functions and situations. Modularisation requires a flexible support system that can incorporate the individual elements/modules. At this stage of our work, the target group for the design needs to be defined.

The design should show how the user can act in different ways, which lead him or her to handle commodities consciously. Our point of departure is the user's self-control of his or her own consumption and the kitchen's function as a node in the chain reaction of the designable metabolism. To ensure it has the required flexibility and can adapt to different physical and technical conditions, it will, like the laboratory kitchen, be modular. Here we would like to mention three further aspects that are relevant to its design: The designable section of the chain reaction: only

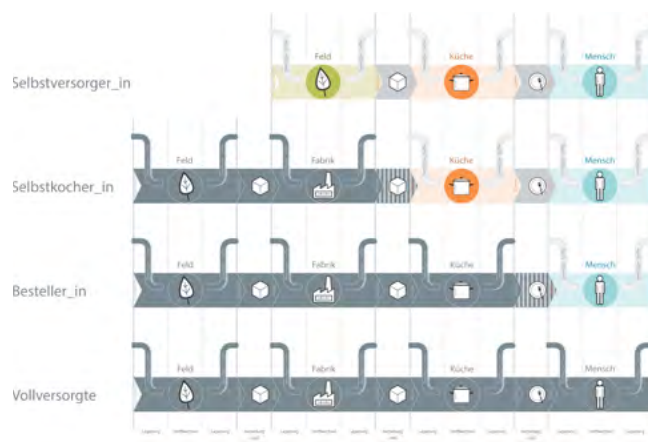

Figure: Visible process chains for different types of providers, K.W. Grosse, J. Krausse, N. Nilaman 2014.

a small part of the global chain reaction can be designed directly by the individual. We are contemplating designing this part so that commodity loss and information loss are as low as possible. This sequence-oriented processing should have a meaningful effect outside the system boundaries of the designable section. A further point of departure is reducing chain reactions to a minimum and situating them in the catchment area and field of

experience that the user can actually shape himself or herself. The experienceable part of the chain reaction: the design should promote the acquisition of fundamental metabolic knowledge and thus create an awareness for the complexity and systemic relationships between global chain reactions and individual action. The pattern of use in the kitchen will be documented and visualised for the user.

The user's self-regulation: by providing information and retrieving experiences, the kitchen will enable its users to reflect on their own patterns of behaviour and regulate themselves.

Following this, a prototype for the »kitchen of the future« will be designed and built. Building the experimental prototype in co-operation with partners from industry is a possibility. This stage of our work will be used to sound out potential network partners on the project's practical applications.



Karl W. Grosse
Base project »The Anthropocene Kitchen«



Joachim Krausse
Associated Investigator

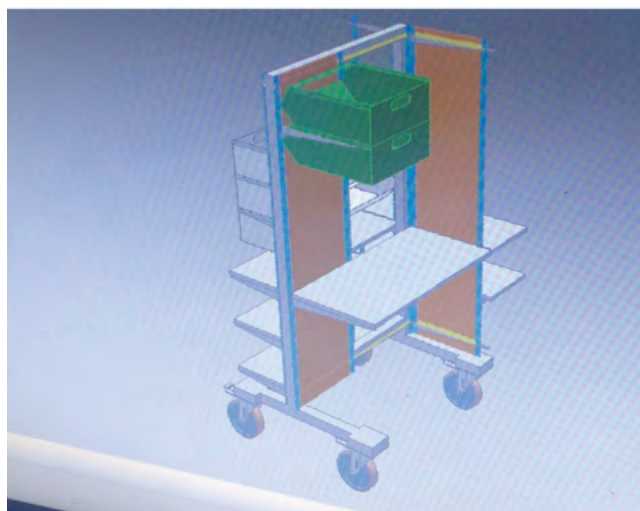

Figure 4: Model for a support system for the laboratory kitchen, K.W. Grosse 2014.

LunchTalk Report *The Recipe of the Future in Pictures*



Ever since the children's university in July 2014, the potato has kept cropping up in the base project »The Anthropocene Kitchen«. And as it goes without saying that as we do the cooking ourselves for a *LunchTalk*, the potato was on the ingredients list this time too. With potato stew and chocolate pudding with custard, the staff of the base project »The Anthropocene Kitchen« conjured up a delicious meal for 40 people with energetic support from Thomas Lilge.

For the stew, we cooked 10 kg of potatoes (waxy), 3 kg of carrots, 2 kg of celeriac, 10 leeks, 10 finely chopped onions in 10 litres of vegetable stock. 20 bay leaves, 5 bunches of fresh marjoram, 10 parsley roots, chives, a little ground nutmeg, paprika, salt and pepper were added for flavour. As an option, diners could complete the main course with Thüringer Knacker sausages.



The desert led to its own problem. As a matter of fact, the chocolate pudding should have made itself entirely. 900 g of whole milk chocolate were melted in 3.5 litres of boiling milk and thickened with 14 tablespoons of cacao, 500 g of sugar and 26 tablespoons of cornflour. But the pudding burnt and was more like a warm cup of hot chocolate. Unfortunately this meant we had to improvise and resorted to 8 packets of custard powder, which we prepared with 4 litres of milk and 40 g of sugar.

The custard turned out brilliantly. We added 4 litres of milk, 30 tablespoons of sugar, 10 vanilla pods and a little cornflour. For the finishing touch, we scattered some grated dark chocolate over the custard.

All in all, we received very positive feedback. People said it tasted delicious, as was shown by the absence of leftovers. Unfortunately, a few plates remained empty for the same reason. We hope that our initiative will inspire other base projects to cook for the *LunchTalk*. As we say in Germany: guten Appetit!



Jens Kirstein

Base project »The Anthropocene Kitchen«



(Photos: Jens Kirstein | BWG 2014)

LunchTalk Report *gamelab.berlin*



The playing field in *Decide & Survive* (*gamelab.berlin* 2014).

Decide & Survive

Decide & Survive is a planning game that has been developed to test Kenneth Waltz's well-known »Theory of International Politics«.

The planning game maps out an international world of states in which test subjects interact with each other and make diplomatic, economic and military decisions as the governments of the states represented in the game, just like real governments. How the test subjects behave during the planning game is extensively documented. The data generated is then used to test the plausibility of theoretical hypotheses. The planning game's aim of verifying an established theory from political science makes it unique. It is therefore especially well suited as an example to examine the connection between games and science and research.

A digital version of *Decide & Survive* is being produced as part of *gamelab.berlin*. The software makes it possible to automate the observation of behaviour and enables shared, online gaming. More information can also be extracted from the data gathered.

The focus will be the points at which the players hesitate or reverse their decisions, how informal negotiations between the players influence gaming behaviour and which game scenarios develop rather aggressively or peacefully. The objective is to test the collection of research data through the games and experiment with the additional possibilities that this produces. *gamelab.berlin* is constantly discussing the possibilities and design issues in the implementation and expanding the original game with new components.

Objective

- Connecting scientific data collection and games
- Expanding the limited real data on political theories
- Measuring players' reactions in detail
- Researching the options for creating digital planning games
- Analysing disparate data

Steven Kawalle & Christian Stein

Steven Kawalle is a member of *gamelab.berlin* and a PhD candidate in political science at the TU Braunschweig. He is interested in using planning games to test political science theories of international relations. He developed the planning game *Decide & Survive* for his PhD thesis. Students at different universities across Germany have played the game.



Christian Stein

Base project »Virtual and Real Architecture of Knowledge«

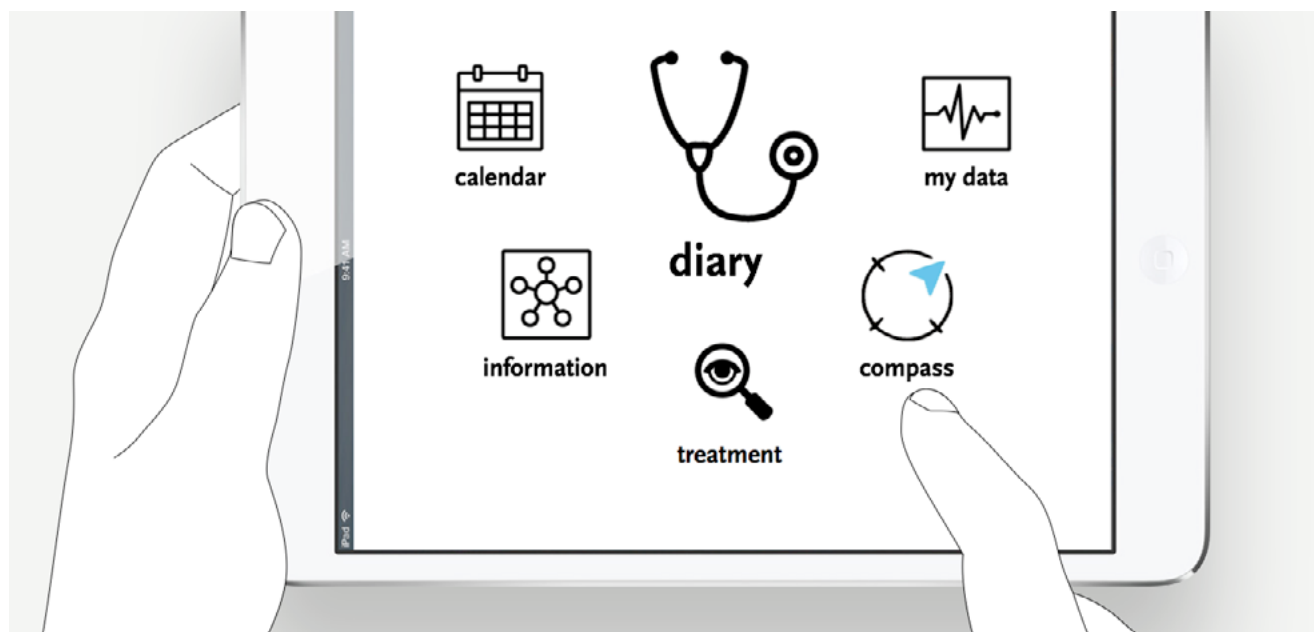

Central navigation functions in doctor-patient co-ordination and communication (gamelab.berlin 2014)

CarePad / The Patient's GPS

Tom Lilge | Anna Roethe | Christian Stein (gamelab.berlin) in collaboration with the base project »Health & Gestaltung«

The care of chronically ill patients both in the hospital and outside is currently facing many new challenges – and opportunities. The co-ordination of care processes between the treatment facilities and the active involvement of patients in the cycle of test results, medical knowledge and treatment strategies has a direct impact on the joint, optimal design of the treatment situation (»Compliance«/»Shared Decision Making«).

CarePad is an interactive, tablet-based app that improves the processes between patient and doctor in medical treatment. By applying current approaches from game mechanics, interaction design and social media functionality, chronically ill patients are provided with an assistance system that can positively influence medical treatment with a focus on patient experiences.

Visualisations of relevant treatment steps and procedures increase the transparency of complex procedures and improve the patient's understanding of them. Integrated knowledge management serves to actively expand expertise and reduces asymmetries of knowledge between the different stakeholders. Medical histories are more effective, misunderstandings are reduced, and patient misinformation as a result of the patient inadequately informing himself or herself (»Dr Google«) is avoided.

In contrast to conventional processes in patient communication, *CarePad* is based on interactive technologies that are in keeping with media habits today. These technologies adapt flexibly to the individual's level of knowledge, interest and information needs, and provide an innovative form of »patient navigation«.



Thomas Lilge
Base project »Experiment & Observation«



Anna Roethe
Base projects »Health & Gestaltung« & »Image Guidance«



Christian Stein
Base project »Architectures of Knowledge«

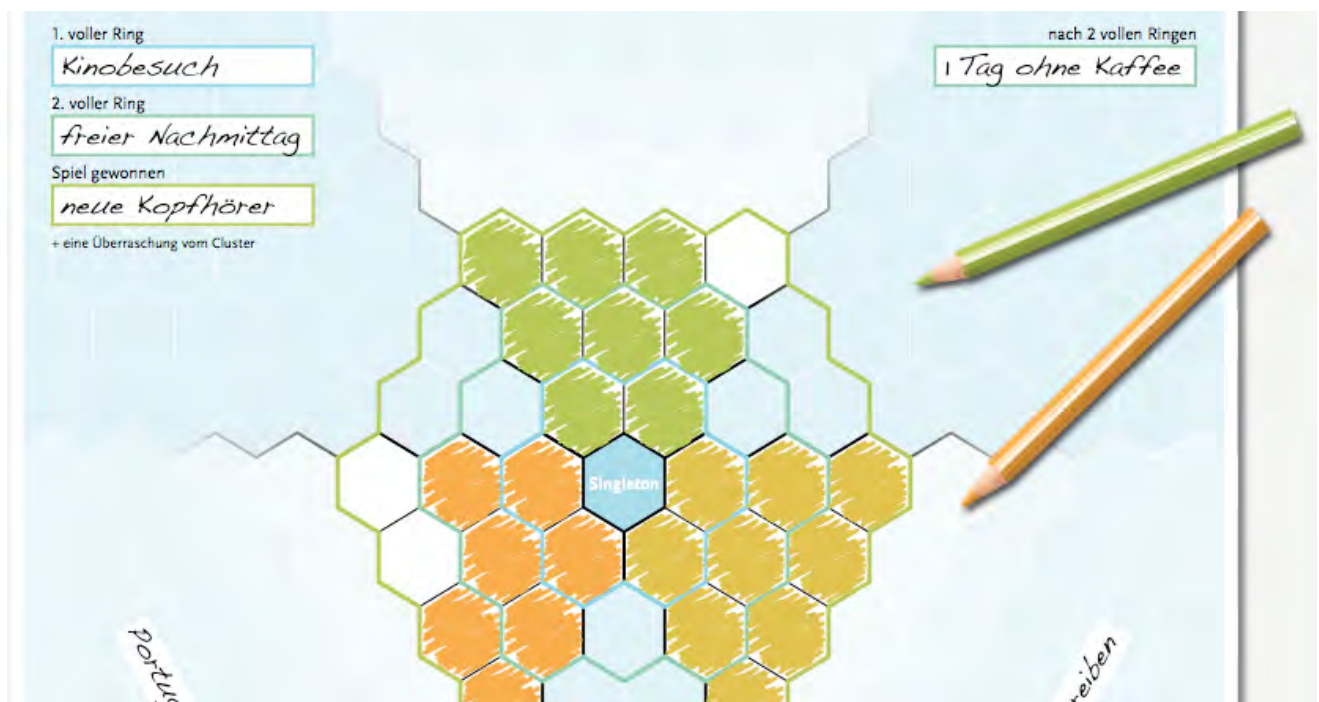

The playing field of *Singleton*

Singleton

Singleton is a game about time – not game time, but our own lifetime. More and more frequently we neglect the things that we actually want. Time management, efficiency optimisation, deadlines and permanently full to-do lists chase us through our daily lives – *Singleton* offers a counterbalance. *Singleton* is a game that systematically applies methods and techniques from game design to generate motivation, endurance and long-term success in all fields where these qualities would otherwise quickly dwindle.

You play *Singleton* with yourself. Each player creates an entirely personal, customised game and continues to develop it round by round. He or she defines the aspects of his or her own life that always get a raw deal and gives them a weighting. When the player spends time on one of these aspects, a field is filled, making progress visible. *Singleton* is more than just feedback on how we spend our own time. *Singleton* offers elements like rewards, boosters, strikes, compensation and special rules with which the players can develop their own strategies. There is therefore no fixed plan but hundreds of individual ways to reach the objective in each game. The players always retain the freedom to play, which is a key part of the attraction of games. The corset of a schedule has no place here! *Singleton* uses game design principles to strengthen the

pursuit of personal goals against the over-professionalised scheduling of work environments. And the best thing about it: it's fun! The high adaptability, controlled by the players, and the simultaneous stabilising effect of fixed rules have been tried and tested in different practical experiments. The test players report a better sense of their own time, a strengthening of their personal priorities, greater motivation and enjoyment in playing the game. The name *Singleton* is taken from its basis as a game with yourself as a unique individual who will never fit into a predetermined corset of a role. Perhaps during the game, we can free up a space that is far away from the drive for efficiency, which too often today has made even leisure a task. You play *Singleton* with yourself and for yourself.



Thomas Lilge
Base project »Experiment & Observation«



Christian Stein
Base project »Architectures of Knowledge«



Depiction of the north-west end of the Ancient Agora of Athens in the reconstruction by the *Foundation of the Hellenic World*.



View from the north-west of the Roman Forum in the time of Augustus in the reconstruction »digitales forum romanum« by the Humboldt-Universität zu Berlin.

The Virtual Agora

The turn towards reconstructions using digital media has prompted a wide range of findings and re-examinations in archaeology and history. Numerous digital reconstruction projects can be cited as examples. One such example is the digital reconstruction of the Ancient Agora of Athens, which the Foundation of the Hellenic World has been involved with since the end of the 1990s. After many sub-projects and side projects, the changes to construction of the Ancient Agora of Athens have been reappraised as far as possible. The public can now marvel at them in the »Tholos«, a virtual theatre in a rotunda. Alongside the great impact of the representation on the public, this design project collects and integrates all available information from highly disparate fields of knowledge. It thereby enriches historical research into a specific site. In line with the latest insights, a project has been set up at the Winckelmann Institute at the Humboldt-Universität zu Berlin to generate the »digitales forum romanum«. The project is a critical scientific reconstruction that focuses less on making the past experienceable and visualising an architectural ensemble than on a historical understanding of this space. The changes in the building structures raise questions about the functions fulfilled by the plaza during the course of decades and centuries.

This spatially oriented thinking is in keeping with a branch of knowledge that emerged almost simultaneously with the »digital humanities« called »sound studies«. It primarily examines the acoustic dimension of spatial experience.

At this interface of a visual reconstruction informed by spatial theory and spatio-temporal sound research in technical acoustics, cultural studies and the arts, the *Virtual Agora Project* attempts to simulate a more holistic experiential environment, which may have served as the basis for architectural and functional decisions. The aim is to orientate the project based on processes in computer game design or to involve designers in the project in order to be able to consciously design the acoustic organisation of the virtual environment with respect to the accustomed audience response. Its ideal is not to reconstruct historical reality completely. Instead, it problematises contemporary visual and acoustic practices. For instance, the majority of digital reconstructions follow the prevalent clichés of architectural models by sacrificing the eminently subjectively constructed experience of space in favour of a representation that has been cleansed of daily life and a largely extra-terrestrial perspective of observation.



Sebastian Schwesinger
Base project »Analogue Storage Media«

In Conversation with ...

The interview series »In Conversation with ...« presents members of the *Interdisciplinary Laboratory* and their present and future projects, research work and events. The format aims to convey issues strikingly and concisely, and to link substantive topics with the people involved. »In Conversation with ...« provides an overview of disciplinary, methodological and substantive diversity in the Cluster and is conceived as a starting point for in-depth discussion and further exchanges between members of the Cluster and external actors.



Claudia Lamas Cornejo
Head of Public Relations & Fundraising

... Sophia Kunze *Individual grant for coaching*

The Cluster of Excellence *Image Knowledge Gestaltung* supports participation in academic and non-academic further training measures for individuals, such as coaching, language training and training in methods and making applications. All female direct members of the Cluster are entitled to apply in accordance with section 5 of the Cluster regulations. The Cluster-Zeitung CZ# regularly presents participants in the programme.

Claudia Lamas Cornejo: Your individual grant was or is for coaching in presentations. Is there a particular reason for it in your career plans?

Sophia Kunze: Last year, there was a workshop for research associates with the consultant Svenja Neupert. It looked at project management with reference to our own academic work. The workshop was really good; I was able to draw lots of useful findings from it and apply them to my work, and I would have liked to have looked in greater depth at structured working and communication with colleagues at some points. That's why it made sense for me to apply for individual coaching with Svenja Neupert precisely because I found the previous workshop with her so helpful.

Claudia Lamas Cornejo: Which topics were covered back in the workshop for research associates?

Sophia Kunze: The issues were to do with how research associates were coping with their own work, in particular against the backdrop of the discrepancy of balancing our

own PhD theses with our work in the Cluster equally, and how to meet all the different claims that are made on us. That meant that time management was an issue, for example; others were structuring tools and decision-making tools.

Claudia Lamas Cornejo: What is Svenja Neupert's background?

Sophia Kunze: She is a sociologist who has been working for more than 20 years as a consultant at the Charité university hospital, the Humboldt-Universität zu Berlin and other academic institutions.

The workshop also looked briefly at how organisation in academic research has changed. The Cluster is a good example that shows how structures in research change. We are working together in different and varying contexts; career paths are changing, and the requirements are different too, both substantively and in terms of organisation. Especially in large research networks like the Cluster, it becomes clear that you can only meet the need to exchange ideas and communicate through a new form of structure.

Claudia Lamas Cornejo: We are looking forward to hearing about your newly won expertise in this area. It would be great if you could keep us posted! Many thanks for talking to us.

... Rasa Weber *Designing with Algae*



Rasa Weber's Algaemy project investigates the potential of microalgae for textile printing. (Credits: blondandbieber/ www.blondandbieber.com/)

Claudia Lamas Cornejo: In your application for an individual grant, the so-called German Design Award 2015 played a role. What is that exactly?

Rasa Weber: The German Design Award is one of the most important design prizes. Candidates are nominated for it and then have to pay a fee in order to be able to present their works.

Claudia Lamas Cornejo:
Which project were you nominated for?

Rasa Weber: With a design colleague, I have developed a project called »Algaemy«, which looks at how microalgae can be used as a natural pigment for textile printing. As part of the project, we have developed an analogue printer and a printing process. It's about a future scenario that aims for practical applicability and to use alternative materials.

Claudia Lamas Cornejo: ... And who nominated you?

Rasa Weber: We were nominated by the *German Design Council*. A fee is payable and will be used for the future exhibition. For the nomination fee, I made an application for a diversity grant. Luckily, it was granted.

Claudia Lamas Cornejo: How will the project »Algaemy« continue?

Rasa Weber: The project »Algaemy« is fortunate to have received a lot of attention in the past year. We have held exhibitions in Germany, the Netherlands, Poland, the UK and even in New York. The federal *Ecodesign* prize was a great honour that is conferred by the German Federal Ministry for the Environment. One point that perhaps makes it so interesting for outsiders is our transdisciplinary work, in which design and research interact. We collaborated with the Fraunhofer Institute on the development of the printer and the printing process, and undertook our aesthetic research there.

In addition to further nominations that we have received, it's now a case of taking the research and the process further, possibly working more closely with other disciplines and starting co-operations with manufacturers in the sector in order to manufacture products with tangible applications.

Claudia Lamas Cornejo: Many thanks for talking to us.

For further information on the studio, please visit:
<http://www.blondandbieber.com/>

... Julia Meer An individual grant for work on Jacqueline Casey

Claudia Lamas Cornejo: Your individual grant took you to Boston for three weeks. What happened there?

Julia Meer: Not Boston, but Cambridge! There's a big difference, as the »Homeland Security Man« explained to me in a strict tone when I arrived.

The reason for my trip was a book and exhibition project that I am working on in co-operation with the MIT Museum. It started in 2012 when I edited the book »Women in Graphic Design«. One of the designers it presented was Jacqueline Casey. Jacqueline Casey was in charge of graphic design at MIT from 1955 to 1989. MIT is one of the first universities to have a so-called Office of Design Services, where anyone associated with the university could turn to when he or she wanted to have something designed. The office really was open to all members of the university, from students to professors, regardless of whether it was a poster for concerts and lectures or a publication. Everything was paid for by MIT. From 1972, Jacqueline Casey was the »Director« of this office, which employed between 3-5 permanent staff.

The designs that Jacqueline Casey developed for MIT are strongly influenced by the Swiss Style in graphic design. Currently her work is experiencing a renaissance, and as the 1992 catalogue is out of print and also no longer really up to date, MIT decided to prepare a new publication and an exhibition on Jacqueline Casey. The MIT's curator, Gary van Zante, asked me if I could come to USA for the preliminary discussions, brainstorming and concept meetings for the publication and exhibition. At that point, MIT didn't yet have any funding for the project. Thanks to the Cluster's individual grants, I could apply for funding to cover my flight costs to Boston.

Claudia Lamas Cornejo: What happened then at MIT?

Julia Meer: We sat together for more than three weeks at MIT, viewed posters and other works by Jacqueline Casey, talked to Jacqueline Casey's former employees and worked on the concept for the publication and the exhibition step by step.



Image 1: Gerda Breuer & Julia Meer: *Women in Graphic Design 1890-2012*, Jovis Berlin 2012.

Claudia Lamas Cornejo: How was funding for the project secured?

Julia Meer: We received offers from three publishers while we were still working at MIT. That meant that, on the one hand, we could plan the project a lot more specifically, and on the other hand, it was a lot easier to apply for further funding. Now that the project will definitely go ahead, there are lots of opportunities for funding, so that I can work on site with the designers on the detailed planning next year, for example.

Claudia Lamas Cornejo: How many people are now involved in the project?

Julia Meer: The main people in charge are Gary van Zante and myself – Gary asked me at the end of my stay if I would like to be a joint editor together with him, which I was really pleased about. Then there will be the designers who will take on the complete production process. And, of course, the other authors who will enrich our research enormously. For example, Dieter Winkler, who worked with Jacqueline Casey for a long time. And Nicolas Negroponte, who played an important part in the development of the Design Office and who will write the foreword. Just last week, we had some very productive talks with Leslie Kennedy, a Swiss-American design historian, who will examine the migration of »Swiss Design« to the USA and the accompanying changes.



Image 2: Two poster designs by Jacqueline Casey. Copyright: Massachusetts Institute of Technology

Claudia Lamas Cornejo: That sounds like a big project for the future! Why is there currently such a great interest in Jacqueline Casey?

Julia Meer: For one thing, her work is quite simply brilliant. It is very visually appealing, but it also demands ›visual intelligence‹ from the viewer. On the other hand, there is a lot of interest in the Swiss Style of graphic design. But for Casey in particular, I'd say that the internet has played a role.

Claudia Lamas Cornejo: How is that?

Julia Meer: The out-of-print 1992 Casey catalogue has been photographed and posted on Flickr, so that lots of people have been able to see it. Her works have been discussed on many blogs in recent years and seen as very inspiring by designers.

Claudia Lamas Cornejo: ... And did you have time for some other visits in Boston?

Julia Meer: I actually went to the Harvard Archives, which was an indescribable experience. Due to time constraints, I only saw seven out of all the libraries – there are about 25 –, but the seven I saw were unbelievably impressive architecturally. And as Harvard is also where the Gropius bequest is housed, the visit to the Harvard Archives also helped my research in the Cluster on the ›Bauhaus figurative mark‹.

Claudia Lamas Cornejo: Thank you for talking to us. We wish you lots of success for the publication – the Cluster Library would definitely be pleased to receive a copy!

The interviews were led by:



Claudia Lamas Cornejo
Head of Public Relations & Fundraising

Review of Events

Workshop *Master's degree programme »Open Design«*



The entrance hall of the Faculty of Architecture, Design and Urbanism (UBA). Photo: Valia Carvalho | Image Knowledge Gestaltung 2014



View of the UBA campus. Photo: Valia Carvalho | Image Knowledge Gestaltung 2014

The »Open Design« workshop took place in Buenos Aires from 24 to 28 October 2014. Its aim was to draw up the curriculum for the master's programme »Open Design«, which will be offered jointly by the Humboldt-Universität zu Berlin (HU) and the University of Buenos Aires (UBA) from August 2015, and to plan how the future lecturers of the master's degree will collaborate with each other. The workshop took place in the Facultad de Arquitectura, Diseño y Urbanismo (Faculty of Architecture, Design and Urbanism) at the UBA and at the Centro de Diseño Tomás Maldonado (Tomás Maldonado Design Centre) in the Polo Científico y Tecnológico of the Argentinian Ministry for Science and Technology (Ministerio de Ciencias y Tecnología).

The international and interdisciplinary master's degree »Open Design« will be offered as a form of further professional development in co-operation between the Faculty of Architecture, Design and Urbanism, the Faculty of Engineering and the Faculty of Natural Sciences at the UBA and the Institute for Cultural History and Theory, the Helmholtz Centre for Cultural Techniques and the Cluster of Excellence »Image Knowledge Gestaltung. An Interdisciplinary Laboratory« at the HU. The title of the master's programme »Open Design« sets out its focus on an interdisciplinary »design turn« in scholarship. The sciences and engineering have been searching for new processes and applications for natural structures and

principles in an ever increasing number of fields since the nanotechnology revolution, if not earlier. By contrast, the humanities, although they may analyse the practices and material culture of knowledge, are scarcely involved in the process of cultural production. Historic-analytical knowledge has until today barely been incorporated in the creative process in design and architecture. The research-oriented master's programme »Open Design« aims to practice interdisciplinary collaboration during the course itself. The programme aims to convey skills that will equip students to confront complex problems with the diversity of methods available today. The master's programme begins in August 2015. The first two semesters on the master's will be completed at the UBA, while students will take a mandatory semester at the HU during the third semester. They have the option of writing their master's dissertation at either the HU or the UBA in the fourth semester.

The interdisciplinary orientation of the international programme calls for the course content to be communicated from more than one disciplinary perspective. Co-teaching events are therefore planned in each semester of the master's programme »Open Design«. At least two experts from different disciplines will jointly develop the content of seminars and compile the teaching material. During the workshop, participants from both universities from architecture, biology, chemistry, design, Computer Science,

and literature and cultural studies found their co-teaching partners and developed ideas for joint teaching.

The teaching in each semester of the programme is oriented around a semester topic that addresses current issues encompassing social, economic and scientific processes. After four days of intensive work in Buenos Aires, the participants were able to set out these strategic components of the master's programme in concrete terms.

The topic for the first semester, »Thresholds«, will explore different aspects of the concept of the threshold. The seminar *Spatial Structures* will examine, compare and interpret the processes adopted in different fields of scholarship with regard to structure and space. The seminar *Media Technologies* will focus on the history of measurement as a means to translate nature into a symbolic system, while the seminar *Design Strategies* will explore the threshold between thought and matter and the threshold itself as a form of communication in the design process.

The theme for the second semester is »Designing Openness: Barriers & Interfaces«. The seminar *Spatial Structures* will analyse the process of converting sequential code to 3D code, as well as the order of information units in texts, codes and objects. Alongside basic skills in software such as LabVIEW, Rhino and Arduino, the seminar *Media Technologies* will convey skills in visualisation, prototyping and statistics. Embedded in an examination of theoretical and praxis-oriented design strategies for »Openness«, the seminar *Design Strategies* will analyse the material and symbolic interdependency of joining and separating as the foundation of the design process across different disciplines and fields.

The third semester will engage with the concept of »Growth«, conceived as a function for changing form, structure and time. As the concept of growth takes different forms in different fields, it is a suitable focus for an interdisciplinary programme of study. While the seminar *Spatial Structures* will analyse the development, change and growth of structures from the three perspectives of design, art history and materials research, the seminar *Media Technologies* will focus on temporal changes in structures as a technological function. Technology here is understood as both the producer and manipulator of time. The seminar *Design Strategies* will examine the different dimensions of growth through which design processes are influenced.

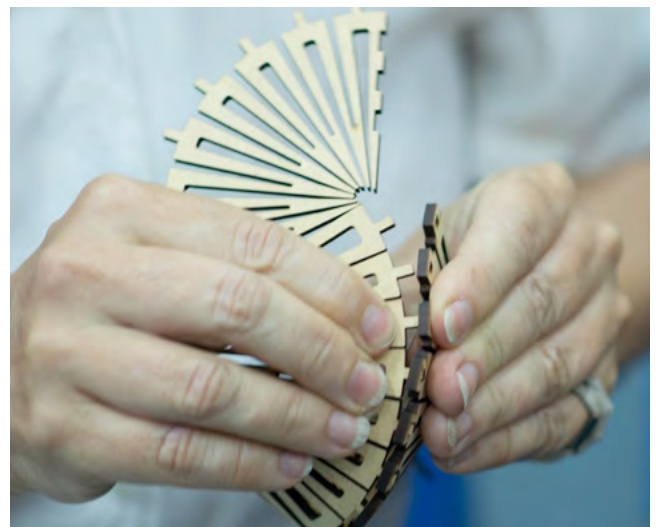

In a workshop led by Patricia Munoz, who investigates morphological structures, models were created from wood and other materials. (Photos: Christian Kassung | BWG 2014)

Each semester will be complemented by laboratory modules that enable innovative, interdisciplinary work. Structured as a practical exercise and as laboratory work, the three laboratory modules will enable students to work on continuous semester projects in theory and practice. As a physical workspace, the laboratory grants the students permanent access to all tools and provides a platform for communication with fellow students. The laboratory represents a functional unit where the knowledge gained in the different seminars can be transformed into practical experience and where design can be translated into a scientific process of experimentation and research.

By working in the Polo Científico y Tecnológico, a kind of cluster at the Ministry for Science and Technology (MIN-CyT) for cutting-edge research in the natural sciences and technology, close contact was established with the ministry. As a result, the MINCyT has put forward the possibility of grants for Argentinian master's students.



The seminar »Spatial Structures« will take place in the first semester of the master's degree »Open Design«. Its content was developed by Carola Becker, Carlos Campos and Christine Schnaithmann. (Photo: Christian Kassung | BWG 2014)

In addition, the HU and the MINCyT have recently signed a co-operation agreement that will enable exchanges between researchers from both countries.

During the workshop, Dr John Dunlop, a researcher at the Max Planck Institute for Colloids and Interfaces and an Associated Investigator at the Cluster, gave a lecture on self-moving materials at the Faculty of Natural Sciences at the UBA. The lecture proved to be an excellent opportunity to present the master's degree to students from other faculties and disciplines.

The workshop has made a vital contribution to drawing up a concrete curriculum for the master's programme »Open Design« and offers a fruitful foundation for further collaboration. This was only possible thanks to the extraordinary motivation and commitment of the participants. We would like to extend our warm thanks to them once again!

Some comments from HU participants in the »Open Design« workshop:

Christian Stein: »When interdisciplinarity is combined with interculturality, language barriers and different ideas of our objectives, you would expect communication to break down. The workshop in Buenos Aires has impressively demonstrated that when there is the right motivation to create something special together, you can sail through all these barriers. It was not just enriching in a whole host of ways, it makes us keen for more!«

Carola Becker: "You organised the workshop fantastically. For me, it was exciting to meet the intelligent and creative minds from Buenos Aires, but also to talk more closely with my own colleagues at the BWG who are not in my base project or my immediate field of research. The ideas for the master's programme and the research interests of the people involved were very diverse, but their focus is still clearly located in design and cultural studies and the humanities. It was difficult for me to contribute my interests and skills as a biologist or to find topics on which I could add something. In my view, that is what makes it all the more astonishing that, by the end, we had still set out a fairly concrete programme of study. And I'm excited to see how it progresses. Buenos Aires is a beautiful, exciting city.«



Valia Carvalho
International Affairs
Coordinator Master's degree »Open Design«

Impressions Annual Conference of the Interdisciplinary Laboratory



The Vice-President for Research, Peter A. Frensch, opened the annual conference and promised support from the Humboldt-Universität for the *Interdisciplinary Laboratory* in order to consolidate its research.

Image Knowledge Section



The art historian Charlotte Klönk moderated the first section, »Image Knowledge«.



Anja Seliger presented her morphological analyses of Gothic ornaments.



Horst Bredekamp opened the section »Image Knowledge« with a lecture with the same title.



Reinhold Leinfelder used comics produced by »The Anthropocene Kitchen« to illustrate participative knowledge generation and the possibilities for spatio-temporal design.



Claudia Godau presented perceptions of data graphics in her lecture.



Thomas Picht, Anna Roethe, Kathrin Friedrich and Moritz Queisner (f.l.) reported from the neurosurgical imaging laboratory.

Knowledge Structures Section



Anke te Heesen, Professor of History of Science, moderated the second section, »Knowledge Structures«.



In a lecture performance, Sabine Hansmann and Peter Koval demonstrated the collaboration between architecture and cultural studies on the issue of mobility. Before the audience, they discovered spatial and kinetic relationships in a map of knowledge architecture.



Observations on successful and failing communication in the Cluster of Excellence on the pictorial, linguistic and stylistic level were the subject of Christian Stein's lecture, »Im Umkreisen begriffen« (Conceptualisation and Circulation of Terminology).



Based on the architectural practice of bricklaying, Michael Dürfeld presented the knowledge structure of architecture.

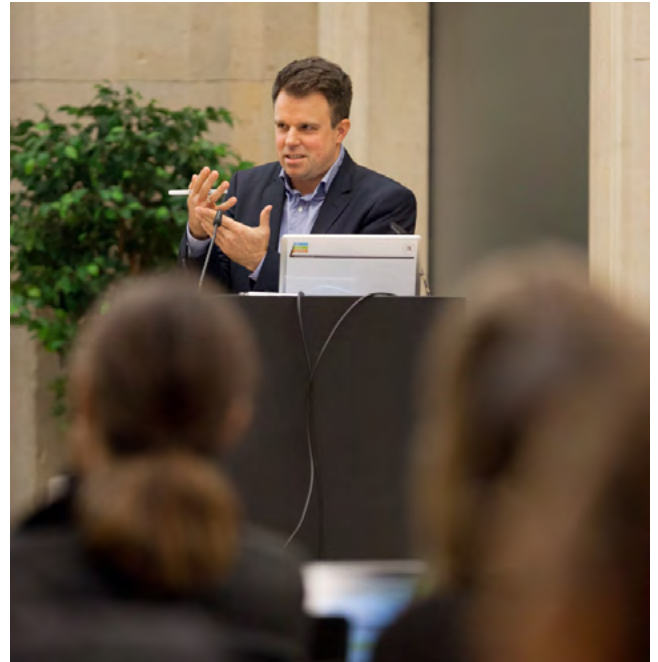

The ambiguities of models play an important role in design processes, as Reinhard Wendler demonstrated.

Gestaltung as Synthesis Section



Wolfgang Schäffner spoke about the design turn and the Cluster of Excellence's interest in developing an interdisciplinary design together with the design disciplines.



Based on a practical example, Anouk Hoffmeister presented the design process and its mechanisms for creating and rejecting ideas and solutions.



Philipp Oswald asked whether design can be systematised and seen as a field of study in the narrow sense and examined how lack of knowledge is handled in design processes.



Under the title »Listening with Hair«, Christian Kassung and Christian Seifert presented their research in the base project »Analogue Storage Media« from the perspective of cultural studies and physics, taking as their subject matter historical and contemporary experiments with self-recording machines and atomic force microscopes.



The design theorist Claudia Mareis moderated the section »Gestaltung as Synthesis«.



Anouk Hoffmeister's lecture prompted interested queries. She illustrated how the moment of rejection is hidden in each phase of zooming in and out, in each change of perspective and adjustment of our internal attitude.



The final discussion was moderated by the physicist Norbert Koch.



The participants continued their conversations and discussions with each other long after the end of the conference.

Report *Anthropocene Campus at the Haus der Kulturen der Welt*

For the last two years, the Haus der Kulturen der Welt (HKW) has offered a kind of home for discussions about the concept of the Anthropocene with its Anthropocene Project.

Numerous exhibitions and lectures have been held, including a meeting of the international working group that is preparing a proposal for a definition of the concept. The group met in person for the first time in mid-October at the HKW after two years' virtual collaboration and presented their work to date to the public. The Anthropocene Curriculum as part of the overall project provided an experimental way to carve out pathways for a transdisciplinary culture of knowledge and learning through new teaching content, means of access and methods. Connecting numerous knowledge cultures and ways of working very definitely plays a key role in the global Anthropocene epoch.

The aim is to transform interdisciplinary exchanges into tools for conveying knowledge in order to lead into a phase of productive collaboration. From 14-22 November, over 120 selected young researchers from the natural sciences, humanities and social sciences, as well as artists, designers and architects, were invited to jointly test the suitability of these tools and develop them further at the Anthropocene Campus. The base project »The Anthropocene Kitchen« was enthusiastically represented in large numbers by Reinhold Leinfelder, Philipp Oswalt, Anne Schmidt, Jens Kirstein, Stephan Barthel and Marc Schleunitz.

The campus programme was structured into three categories: representing, connecting and claiming. Three seminars were offered in each category. All campus participants chose a seminar in advance from each category. Almost all the seminars examined very specific case studies, that is, places or tasks, and connected their discussions to them. Until autumn next year, the results, materials and multimedia documentation will be published on a project website to enable a new edition of the campus and continued development of its curriculum around the world. The central element here is the Anthropocene Coursebook, produced by the campus participants. The campus was accompanied by a programme of lectures and discussions, which gave insights into the development of the curriculum.

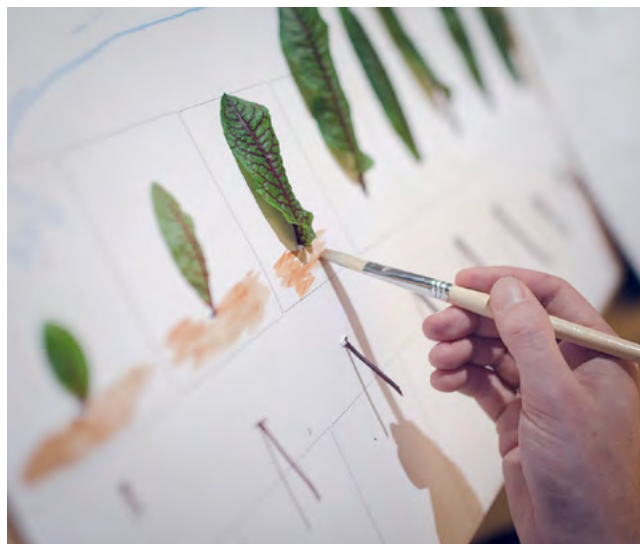

In the course *Slow Media*, complex issues were illuminated using comic sketches. (Photo: Jens Kirstein | BWG 2014)

Stephan Barthel and Jens Kirstein took part in the seminar *Slow Media*, which was developed by Reinhold Leinfelder and others. It examined slow media (for example, museums, exhibitions and comics) as a tool for raising awareness of the Anthropocene in society. The slow museum visit, where the visitor interacts with physical and visual objects or reading comics with the high degree of participation this entails, strengthen both the memory process and the motivation for action. These forms are a counterbalance to the commercial, fast and furious media, which are able to stimulate complex thought processes effectively through a rapid flow of information.

The general discussion in the seminar looked at the topic: What does slow actually mean? Which media are suitable for illustrating the concept of the Anthropocene? Is a round of introductions, where course participants listen to each other, in itself a kind of slow media? The focus in the rest of the seminar turned to active learning through praxis and participation. In small groups, the participants explored the core theme and looked more closely at the issue of conveying knowledge by highly diverse means. For the coursebook, an outline for a Listening to the Anthropocene Museum is to be drawn up based on the group activities and seminar work.



An example representing nature's *micro* and *macro*dynamics by Jens Kirstein's (behind the camera) group.
(Photo: Jens Kirstein | BWG 2014)

Anne Schmidt attended the seminar *Modelling Wicked Problems*, which was designed and led by Miriam Diamond, Paul Edwards and Pablo Jensen, amongst others. Its fundamental assumption was that the majority of challenges in the Anthropocene epoch, such as man-made climate change, the extinction of species, switching to renewable energy sources, are *wicked problems*. Supposed solutions lead to new problems, as these are formulated differently by different interest groups, who compete with each other when a solution is attempted. In addition, the parameters that could contribute to solutions are changing, for example, due to finite resources. The aim of the seminar was to use the work with a model to reach an understanding of both models in general and the complex interconnections in system-determining factors, and to test solution strategies. The fundamental principles, strengths and weaknesses of such models were first illustrated using the *World3 model*, which was developed by *Meadows et al.* for the *Club of Rome* and visualises the *limits to growth*. Analytical models reduce the complexity of systems so much that a dynamic interaction of system-determining factors is possible. One of the ways in which the validity of models is measured is the precision of their forecasts for past developments. But it is a fallacy to believe that such models can also make statements about the future, and the slogan's seminar was: *All models are wrong, but some are useful*.

In several practical exercises with the *Global Systems Simulator*, the seminar participants were able to try out strategies and examine the effectiveness of narratives for exploring issues such as the tensions between supply and demand for resources, in energy supply and population growth. It was not entirely surprising to see how slowly a complex system reacts. More surprising was the unexpected reactions generated by adjusting parameters that initially seem to have no connection to each other and, above all, how our own mental models frequently let us down.

The Anthropocene concept in scholarship still lacks cultural nuances and historical depth. In some aspects, it appears very much an open and undefined concept. The seminar *Imaging the Anthropocene*, which Philipp Oswalt helped design and led as the lecturer, set itself the objective of exploring in depth the meaning of representations of the Anthropocene in images and generating its own images. As one of the participants, Marc Schleunitz analysed existing images and forms of representation. In order to do justice to the complexity of the Anthropocene concept, four different perspectives were adopted by four groups:

Terra forming – the Anthropocene is shaped by conscious and unconscious processes, which influence geological layers and effect systems of regional, national and global dimensions.



In the seminar *Anthropogenic Landscapes*, a critical light was shed on the prepared case studies. (Photo: Jens Kirstein | BWG 2014)

Anthropos – man as a factor that actively shapes his indirect and direct environment has an enormous geophysical impact on earth systems. However, the significance of man, that is to say, the anthropos, has not been adequately resolved: how can the active subject be located in the predominantly collective whole of humanity and thereby illustrate the significance of each individual in the Anthropocene? What image do we have of this anthropos? How does it differ from how we have previously seen humans? *The non-human* – much of what is covered by the anthroposphere is not directly connected to man, but it is made by him or influenced by him – whether this is the billions of organisms that man has integrated into ecosystems or ecosystems that are used in different ways. The role of nature and the extent to which nature still exists under the influence of the anthropos were a further important aspect in this field of enquiry.

Times before and after – the Anthropocene is an epoch that occupies a particular space in the earth's timeline. What perspectives arise from looking at *before* and *after*? Man uses the planet, which for many years had created an environment that allowed man to be man in the first instance. On the other hand, man influences the processes that he imposes on the planet. By consequence, this planet's future is a man-made one. What will this future look like? Alongside formulating results in individual groups, the focus was first and foremost on the process of result production. Discussions about forms of representation, target audiences and interpretation could be observed in all groups. A need for a meaningful representation of the Anthropocene based on a scientific, artistic and social foundation was noticeable amongst all participants.

In the seminar *Technosphere & Co-Evolution*, Jens Kirstein explored the relationship between individual human

intention and its technological development. As the point of departure for an intensive discussion, the technosphere was split into its components *techne*, the connection between technology and science, and *sphaira*, the implied image of a closed system. Global transformations, their material scope and dynamics promote the expansion of a technosphere and go beyond human intention, as a result of which we are but a small fraction of these transformations. To understand this development, the post-campus will work on an Anthropocene timeline.

The Anthropocene is a complex and multivalent concept that involves reassessing our understanding of the world and will lead to a new approach to the opportunities for knowledge and its practices. The limits of the traditional disciplines of the natural and social sciences and the humanities become clear and lead to a greater acceptance of inter- and transdisciplinary approaches. These are not declared to be a universal remedy as limiting factors and perceptions arise, as a result of which some things become visible, but others disappear. The focus of the course *Disciplinarity*, which Stephan Barthel took part in, was teaching, learning and unlearning, as well as the theoretical meta-level of and reflection on participants' own disciplines, as well as inter- and transdisciplinary research.

In one of the first exercises, communication forms were practised with components from games. In successive *discipline slams*, the participants presented their disciplinary backgrounds and the key characteristics of their disciplines in a minute. Bronislaw Szerszynski followed with a report on different knowledge forms, their transformation and combinations. Mark Lawrence spoke about interdisciplinarity and transdisciplinarity with a case study on *geoengineering*. Following the talks, groups formed and



View of the former site of VEB Elektrokohle Lichtenberg, used today for international wholesale businesses (Dong Xuan Center). (Photo: Jens Kirstein | BWG 2014)

developed different forms of communication – from the storyboard for a film right the way through to web-based applications –, either with reference to the wider ensemble of knowledge or to the specific case study of *geoengineering* and taking into account the pitfall of disciplines described above.

Marc Schleunitz and Anne Schmidt took part in the seminar *Valuing Nature*. The concept of the seminar evolved in collaboration between the physicist and historian Sabine Höhler, the artist Natalie Jeremijenko and the biologist Ioan Negrutiu. As a preliminary task to tune into the seminar topic, the participants were asked to describe a tree in their neighbourhood and assess its properties and significance. The idea was to encourage reflection on whether and how the value of a tree should be measured, beyond the material value of its wood, and whether this value can be converted into monetary units. When a value was set, a follow-up question arose: who should stand up for this tree and its rights?

The seminar threw up many questions that could not be answered during the session itself. It was intended as an opportunity to critically examine the idea of including *natural capital* in national accounts and the measures already taken by different authorities (the EU, the World Bank, etc.) to this effect. Subjecting ecosystems to the logic of the markets makes their value negotiable. What is more, it leads to a further drifting apart of those who can afford to negotiate on this issue and those who cannot afford to do so. This seminar in particular has shown that its curriculum, which had been planned well in advance, remained negotiable right up until the last minute and that the seminars could produce their very own, critical and productive dynamics, which is a reason to be optimistic. Man-made landscapes and those changed by man cover large expanses of the earth's surface and are



Looking behind the container shows human influence on a small scale. (Photo: Jens Kirstein | BWG 2014)

the result of the continuing direct interaction between mankind and ecosystems. This socio-ecological melting pot was examined by Anne Schmidt, Marc Schleunitz and Jens Kirstein in the seminar *Anthropogenic Landscapes* in the category *Claiming*. The curriculum of this seminar was developed by the anthropologist Elena Bougleux, the Berlin architect Arno Brandlhuber and the ecologist Erle Ellis. In preparation, each of the participants prepared a case study of their own choosing on a *man-made landscape*. This exercise was intended to stimulate reflection on the development of tools for examining man-made landscapes in the narrow sense and to provide the basis for a discussion on the definition of the concept of the anthropogenic landscape in the wider sense. One of the assumptions this seminar was based on is that man has been changing the surface of the earth for millennia (e.g. by clearing forests for agriculture and hunting), and the extent of this can hardly be measured today. As a consequence, we are surrounded by anthromes, not biomes. An optimistic overall mood prevailed, in contrast to the concept of the Anthropocene, which is predominantly characterised by crisis. This attitude allows scope for the development of ideas that are not solely limited to reactions to loss and, by consequence, restoration, and that decisively reject the romanticisation of the Anthropocene. The Dong Xuan Center in the Lichtenberg district of Berlin served as a comparative case study. The centre was examined from many different aspects and from a wide spectrum of disciplinary perspectives. At the end, the comparison inspired an intense discussion about negotiating between the positions of conservation and absence of action, and the need for transformation through action, a question that kept reappearing in the rest of the programme at the campus.

The Anthropocene is a concept for a global phenomenon, a geological period, and it should be possible to detect it everywhere, worldwide and at every point in the geological layers using defined parameters. It does not differentiate between locations and regions, and says nothing about disparities. It does not represent the individual but rather the total of our allegedly collective action. The questions that the Anthropocene Project has tackled and that were discussed on the campus ultimately affect us all because they concern the relationship of each one of us to the earth, to the big whole, and to all other people today and in the future. How do we want to live and how can we contribute to leaving behind a liveable world for the next generations? Those are questions that have always been valid and should not be first addressed now and with the concept of the Anthropocene.

The campus was an ideal place to exchange ideas and reflected the research approaches of our *Interdisciplinary Laboratory Image Knowledge Gestaltung* in varied ways. It was also positive to see so many different disciplines and views represented at the campus. Many other views on the Anthropocene, in particular religious, linguistic and cultural, could not be articulated, and this was criticised and should provide food for thought for further research and discussion.



Stephan Barthel

Base project »The Anthropocene Kitchen«



Jens Kirstein

Base project »The Anthropocene Kitchen«



Marc Schleunitz

Base project »The Anthropocene Kitchen«



Anne Schmidt

Base project »The Anthropocene Kitchen«

Imprint

Published by:

Image Knowledge Gestaltung. An Interdisciplinary Laboratory
Cluster of Excellence at the Humboldt-Universität zu Berlin

Editor in chief:

Claudia Lamas Cornejo (responsible)

Authors: Bettina Bock von Wülffingen, Valia Carvalho, Karl W. Grosse, Steven Kawalle, Jens Kirstein, Joachim Krausse, Thomas Lilge, Anna Roethe, Anne Schmidt, Marc Schleunitz, Sebastian Schwesinger, Christian Stein

Editorial team:

Sophia Gräfe, Kathrin Bauer, Frauke Stuhl, Amaya Steinhilber

Layout:

Kerstin Kühl

Cover photo: The cover photo shows an image of a netted fabric that was designed by Kerstin Kühl as the motif for the first annual conference of the Interdisciplinary Laboratory *Image Knowledge Gestaltung*. The netted fabric and its spectrum of colours that flow into each other stand for the overlapping of and connections between the disciplines and researchers represented in the Cluster.

Contact:

Image Knowledge Gestaltung. An Interdisciplinary Laboratory

Cluster of Excellence at the Humboldt-Universität zu Berlin

Email: bildwissengestaltung@hu-berlin.de

Tel.: +49 30 2093-66257

www.interdisciplinary-laboratory.hu-berlin.de

Directors:

Horst Bredekamp & Wolfgang Schäffner

Academic Director:

Deborah Zehnder

Postal address:

Humboldt-Universität zu Berlin
Unter den Linden 6, 10099 Berlin

Street address:

Sophienstraße 22 a, 10178 Berlin